

FAG Wheel Bearings

Disassembly and Assembly



The content of this brochure shall not be legally binding and is for information purposes only. To the extent legally permissible, Schaeffler Automotive Aftermarket GmbH & Co. KG assumes no liability out of or in connection with this brochure.

Copyright ©
Schaeffler Automotive Aftermarket GmbH & Co. KG
April 2019

All rights reserved. Any copying, distribution, reproduction, making publicly available or other publication of this brochure in whole or in extracts without the prior written consent of Schaeffler Automotive Aftermarket GmbH & Co. KG is prohibited.

Schaeffler in the Automotive Aftermarket – more innovation, more quality and more service.



Schaeffler REPERT – the service brand for garage professionals.

With REPERT, we offer a comprehensive service package for our products and repair solutions. Looking for specific information about damage diagnosis? Are you in need of particular tools to help make your everyday garage routine easier? Whether online portal, service hotline, installation instructions and videos, training seminars, or events – you get all technical services from a single source.

Register now for free, in just a few clicks, at: www.repxpert.com.

Schaeffler in the Automotive Aftermarket – always the first choice for vehicle repair.

Whenever a vehicle needs to go to the garage, our products and repair solutions are first choice to fix them. With our system competence in transmission, engine, and chassis, we are a reliable partner around the world. Whether passenger cars, light and heavy commercial vehicles, or tractors – our optimally tuned components allow fast and professional parts replacement.

Our products are based on a comprehensive systems approach. Innovation, technical expertise, and the highest material and manufacturing quality make us not only one of the leading development partners for vehicle manufacturers, but also a pioneering provider of value-retaining spare parts and complete repair solutions for clutches and clutch release systems, engine, and transmission applications, and chassis applications in original-equipment quality – right up to the appropriate special tools.

With our FAG brand, we are the specialist for chassis repair and supply a wide range of products and repair solutions. Our portfolio for this includes wheel bearings, steering and suspension parts, drive shaft assemblies, and strut mountings. By using state-of-the-art sealing and surface coating technologies, we offer the same high level of quality throughout the entire portfolio. Every individual component, including the smallest accessory part, is developed and tested according to Schaeffler quality standards. Therefore, our products ensure safe and agile road handling in every driving situation.

SCHAEFFLER REPERT





REP XPERT

SCHAEFFLER
F-6
WheelSet

Contents

1	Introduction	6
2	Troubleshooting instructions	7
3	Tools for repairing wheel bearings	8
4	Wheel bearing generations	10
5	General repair instructions	12
6	Wheel bearing repairs	13
6.1	Tapered roller bearing	13
6.2	Generation 1	19
6.3	Generation 2	24
6.4	Generation 2D	27
6.5	Generation 2.1 with snap ring	30
6.6	Generation 3	35
7	Wheel bearing repair solution as a safety system	38

1 Introduction

Wheel bearings are designed to last the lifetime of the vehicle. However some fail at an earlier stage. Regardless of the quality of a wheel bearing, there are a wide range of influencing factors that might cause it to fail prematurely, such as poor road conditions or contact with curbs.

Irrespective of the cause, it is absolutely vital for vehicle technicians to be able to diagnose damage to bearings and to correctly mount a new one. After all, customers need to be confident that they will be able to drive their vehicles safely on the road again.

Like many of the other components in a vehicle, wheel bearings have passed through many different development stages. Nowadays, wheel bearings are not simply either ball or tapered roller bearings. For many years, compact wheel bearing units have been available with built-in wheel hubs or mounting flanges. These components now also supply speed information to driver assistance systems such as ABS, ESP, navigation systems, etc.

This makes it all the more important that wheel bearing repair work is carried out carefully by vehicle technicians with the appropriate expertise. The use of brute force to wield a large hammer should not be the standard operating procedure of a wheel bearing repair professional. The consequences might not be immediately noticeable. But they may result in premature failure and the associated customer complaints. The multipole encoder, which records the wheel speed, may also be damaged.

In order to avoid this happening, repair work should be carried out by vehicle technicians with the necessary expertise who have access to the right tools.

Even highly experienced vehicle technicians can benefit from glancing through this brochure. It explains the different repair methods and will undoubtedly yield an idea or two for your day-to-day work in the garage.



2 Troubleshooting instructions

Before rushing into things or replacing a wheel bearing "just in case", your first task should be to diagnose the problem. This is not always as easy as it sounds. It is remarkably easy to be led astray, and – in a worst-case scenario – to replace the wheel bearing on the wrong side of the vehicle.



Your first move should therefore be to talk to the customer and to carry out a test drive. After completing these two steps, you will generally have some idea about where the fault may lie.

Potential questions to ask the customer include:

- Is the vehicle making any odd noises?
- When can these noises be heard?
- Do the noises get louder when the vehicle's speed increases?
- Do the noises change when the vehicle goes around a corner?
- Do the noises get louder when turning left or turning right?
- How long has the vehicle been making these noises?
- Has the vehicle been subject to unusually heavy stresses, for example very poor road conditions, off-road driving, potholes, high payloads, extreme driving style, extreme weather conditions?
- Has the vehicle been involved in any accidents?
- Has any work been carried out on the axle suspension or the final drive?
- Was it necessary to apply force to dismantle the wheels during the last tire change?

The answers to these questions may make it clear at this stage whether a faulty wheel bearing is to blame or the root of the problem lies elsewhere.

Noises that are heard when cornering are generally assumed to be caused by damage to a wheel bearing. The side with the problem is usually the one on which the vehicle is subject to strain. For example, if the noises become louder when the vehicle is turning right, the left wheel bearing may be faulty. However, there are unfortunately no hard and fast answers.

That's why it's important to continue investigating the noises after placing the vehicle on the lifting ramp. Faults can often be identified on the ramp by turning or tilting the wheels.

If material fatigue is assumed to be the cause (as may be the case for vehicles with very high mileages), the best course of action is to replace both wheel bearings on the axle. After all, both wheel bearings have chalked up the same number of miles and experienced approximately the same stresses and strains.

FAG WheelSet – safe choice for garage professionals

That's why Schaeffler in the Automotive Aftermarket offers a complete wheel bearing repair solution with the FAG WheelSet. Besides the fitting wheel bearing every FAG box contains all necessary accessory parts required for a professional repair.



3 Tools for repairing wheel bearings



Vehicle technicians generally perform repairs to tapered roller bearings using standard tools. A hydraulic standing press is only necessary for removing and reinstalling the outer rings.

In many garages, these rings are disassembled and mounted using a hammer and mandrel. Yet it is important to note that this method can result in damage to the bearing seat in the wheel hub and to the outer ring.

It is therefore a good idea to disassemble the outer ring using an appropriate puller, and to mount it using the press and a suitable thrust piece.



Professional special tools for repairing pressed-in wheel bearings are available from many suppliers. They generally differ in terms of their operation, design and – last but not least – their price.

As a general rule, a distinction is made between:

- special tools with a manually operated spindle (economical option, high level of force needs to be applied, wear to the spindle)
- special tools with hydraulic support (more expensive option, less force needs to be applied)

Both of these tools allow professional removal and installation operations to be carried out on vehicles. They ensure that the steering knuckle does not need to be removed for wheel bearing repairs.

If the necessary special tools are not available, the only option is to remove the steering knuckle and carry out the wheel bearing repair on a hydraulic standing press. As a general rule, however, wheel alignment is necessary after the repairs.

PULLER AND THRUST PIECES FOR THE HYDRAULIC STANDING PRESS



The puller and thrust pieces for the hydraulic standing press should be available in every well-stocked garage

SPECIAL TOOL WITH HYDRAULIC SUPPORT



Special tool with hydraulic support for professional vehicle repairs

Removing the wheel bearing from the steering knuckle and replacing it are not the only important tasks, however. On certain Generation 1 and 2 wheel bearings, the inner ring must be pulled off the wheel hub, since it remains on the flange during disassembly.

This means that another tool is required for the repair work. An appropriate puller allows the bearing inner ring to be pulled off the wheel hub using a spindle.

Other repair methods that may be common in garages might result in damage to the bearing seat or the wheel hub.



Special tools are vital for Generation 2.1 wheel bearings. There are two things to remember during this process; firstly the pressing force must be applied via the outer ring, and secondly the snap ring must be held in position so that it ultimately engages into designated groove in the steering knuckle.

INNER RING PULLER



The inner ring puller is available in different sizes for different bearing diameters

CLAMPS



The clamps ensure firstly that the snap ring is held in position during installation. They secondly guarantee that the forces are routed via the outer ring during the pressing-in process

4 Wheel bearing generations

Single tapered roller bearings arranged in pairs are becoming increasingly uncommon today. They are being replaced by wheel bearing compact units that are able to take on more and more peripheral functions from generation to generation. This trend is also evident in the garage environment. For example, in the past, garages had to lubricate tapered roller bearings during assembly, and regularly perform setting work during an inspection. This isn't necessary with compact bearings.

The following overview illustrates wheel bearing development over the years, with all wheel bearing types currently in use in modern vehicles.



1



2



3



4



5



6



7



10



11

1 Standard tapered roller bearing
Dismountable tapered roller bearing

2 Generation 1
Double-row angular ball bearing with/without multipole encoder

3 Generation 1T
Double-row tapered roller bearing with/without multipole encoder

4 Generation 1
Double-row angular ball bearing with snap ring, with/without multipole encoder

5 Generation 2
Double-row, sealed angular ball bearing with conventional encoder (non-driven wheel)

6 Generation 2
Double-row, sealed angular ball bearing with multipole encoder (non-driven wheel)

7 Generation 2D
Double-row, sealed tapered roller bearing (non-driven wheel)

8 Generation 2.1
Double-row, sealed angular ball bearing with orbitally formed shoulder, multipole encoder and snap ring (driven wheel)

9 Generation 2.1
Double-row, sealed angular ball bearing with orbitally formed shoulder, multipole encoder and snap ring

10 Generation 3
Double-row, sealed angular ball bearing with orbitally formed shoulder

11 Generation 3
Double-row, sealed angular ball bearing with orbitally formed shoulder, multipole encoder and sensor

12 Generation 3.2
Double-row, sealed angular ball bearing with orbitally formed shoulder, multipole encoder

13 Generation 3.2
Double-row, sealed angular ball bearing with orbitally formed shoulder, multipole encoder, face spline and LFT



8



9



12



13

5 General repair instructions

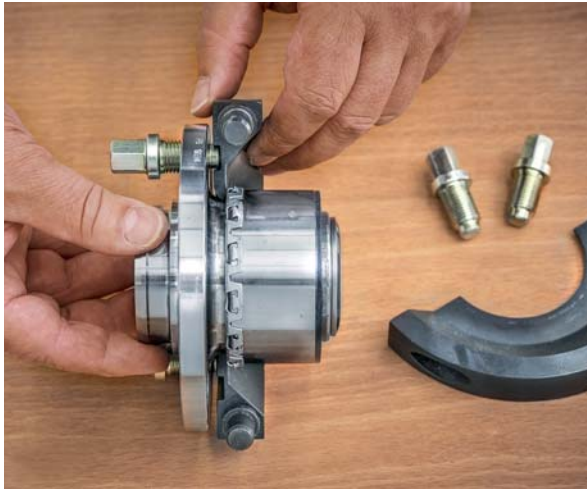

Wheel bearings are safety-relevant vehicle components, which are manufactured to very tight tolerances using high-precision machinery. That makes it all the more important to remember this during repairs and to work carefully.

The following sections describe repairs to the various wheel bearing generations **using examples**. Only the wheel bearing repairs are shown. The removal and installation of the brake system and the driveshaft (for driven axles) are not covered.

The following vehicles were used for the repairs:

- Tapered roller bearings (non-driven axle) – BMW 6 Series, front axle
- Generation 1 (driven axle) with ABS – Renault Clio III, front axle
- Generation 2 (non-driven axle) – Volkswagen Bora, rear axle
- Generation 2D (driven axle) – Audi A4 (8K), front axle
- Generation 2.1 (driven axle) – Skoda Roomster, front axle
- Generation 3 (driven axle) – Volkswagen Golf VI, front axle

The following points should be noted:

- Previously used wheel bearings must not be reinstalled. Tapered roller bearings represent an exception to this rule, but need to be cleaned and regreased prior to reinstallation
- Use bolts, nuts or other accessories from the FAG wheel bearing kit during installation
- Ensure that the working environment is clean during the repairs
- Wheel bearings that have been dropped may already have suffered initial damage. They should not be installed in vehicles
- Wheel bearings with an integrated multipole encoder, e.g. for ABS, should not be placed near a magnet under any circumstances
- The bearing seat should be inspected after removing the old wheel bearing. Deep scoring will affect the seating of the new bearing. Large stains also indicate possible oval deformation. If this is the case, the steering knuckle must be replaced. The new bearing may otherwise move in the seat
- Do not apply force during installation
- Use a suitable tool/special tool
- Never place the vehicle on its wheels or move it without having tightened the central nut/bolt
- Never lay down the wheel bearing on the multipole encoder side
- Tighten all bolts and nuts to the tightening torque specified by the vehicle manufacturer. Further information can be accessed via www.rexpert.com, for example
- Carry out repairs in line with the vehicle manufacturer's specifications
- Follow any installation instructions in the packaging
- Only take the wheel bearings out of the packaging when you are ready to install them
- For vehicles with a multipole encoder: Use the FAG detector card

6 Wheel bearing repairs

6.1 Tapered roller bearing

Preparatory work:

- Remove the wheel
- Loosen the brake caliper and hang it to one side in such a way that there is no tensile load on the brake hose
- Remove the brake pads if necessary
- Remove the brake disc



- Remove the protective cap



- Take out the split pin
- Unscrew the castellated nut



- Remove the outer tapered roller bearing and detach the wheel hub from the stub axle



- Clean the stub axle
- Check that the bearing seat and the thread are in perfect condition



- Remove the rotary shaft seal and take out the inner tapered roller bearing



- Pull both bearing outer rings out of the wheel hub using a puller



- Clean the wheel hub and inspect the bearing seat



- Press new outer rings into the wheel hub



- Grease the new inner bearing

Important:

Incorporate sufficient grease between the inner ring and the rolling elements.



- Insert the inner bearing



- Install the rotary shaft seal and lightly grease the hub seal
- Pack the hub grease between the two bearings



- Attach the wheel hub to the stub axle
- Grease and install the outer bearing



- Insert the washer and tighten the castellated nut by hand



- Tighten the castellated nut until the bearing has settled in place. The wheel hub must be turned at the same time
- Then loosen the nut until the washer can be moved using a screwdriver but still has a little drag



- install the new split pin and protective cap



Final work:

- Mount the brake disc
- Attach the brake caliper
- Mount the road wheel and tighten to manufactures specified torque setting
- Carry out test drive and re-check the wheel bearing clearance



6.2 Generation 1

Preparatory work:

- Loosen the central nut/screw on the driveshaft
- Remove the wheel
- Loosen the brake caliper and hang it to one side in such a way that there is no tensile load on the brake hose
- Remove the brake pads
- Remove the brake carrier and brake disc
- Disconnect the lower ball joint from the steering knuckle
- Take out the axle shaft
- Remove driveshaft from steering knuckle



- Mount the wheel hub puller

Important:

The diameter of the thrust piece should be only slightly smaller than the diameter of the wheel hub.

- Activate the hydraulic press and pull off the wheel hub

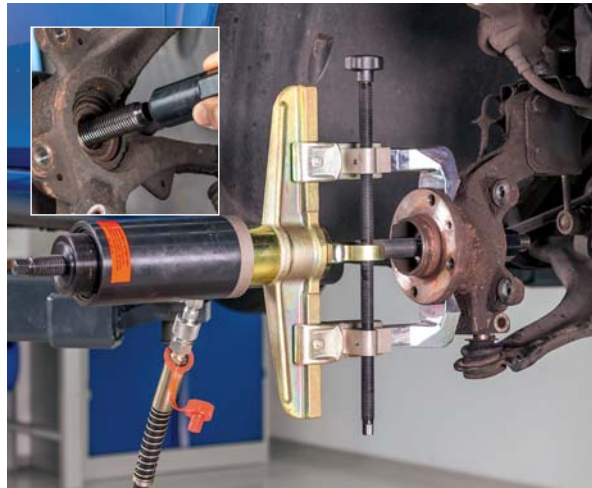

- Attach the puller and pull the inner ring off the wheel hub by turning the spindle



- Clean and inspect the wheel hub bearing flange



- Remove the circlip

Note:

If another circlip is located behind the bearing, this must also be removed.



- Apply a thrust piece of the same size as the outer diameter to the wheel bearing from the rear
- Install the hydraulic cylinder with the spindle



- Pull the wheel bearing out from the wheel bearing housing



- Inspect and clean the bearing seat

Note:

Insert the rear circlip if applicable.



- For vehicles with ABS: Identify the installation direction

Important:

The side with the encoder must be installed towards the interior, i.e. the sensor side.

Note:

The FAG detector card can be consulted via www.repxpert.com, for example.



- Prepare the wheel bearing installation tools

Important:

The wheel bearing must be pressed over the outer ring. In order to do so, a thrust piece is required which is slightly smaller than the outer diameter of the bearing.



- Attach the tool in alignment and without tilting
- Press the wheel bearing on until it stops

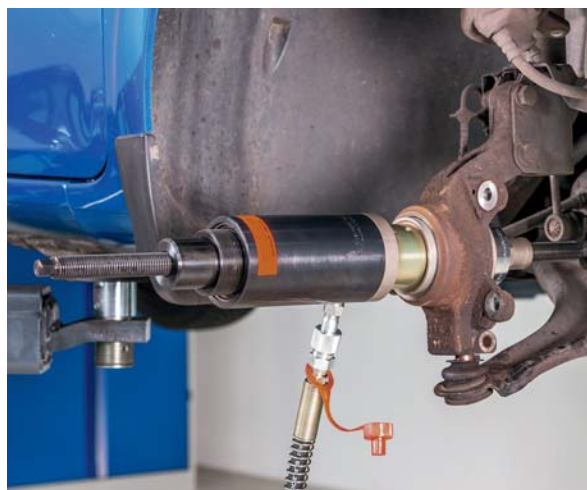

- Insert the circlip

Important:

The opening should be facing downwards. This will prevent any moisture accumulating between the wheel bearing and the circlip.



- Prepare the wheel hub installation tools

Important:

The rear thrust piece must correspond to the diameter of the inner ring.



- Press wheel hub into the wheel bearing

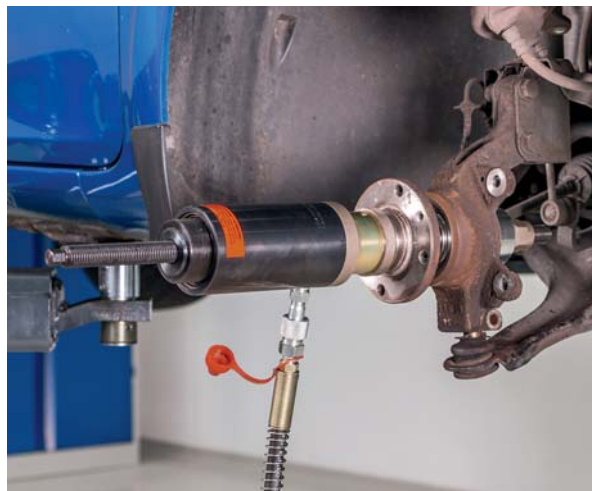

Final work:

- Install the ABS sensor
- Install the driveshaft
- Attach the lower ball joint to the steering knuckle
- Install the brake disc, brake carrier, brake pads and brake caliper
- Tighten the central nut/screw to the tightening torque specified by the manufacturer
- Mount the road wheel and tighten to manufactures specified torque setting

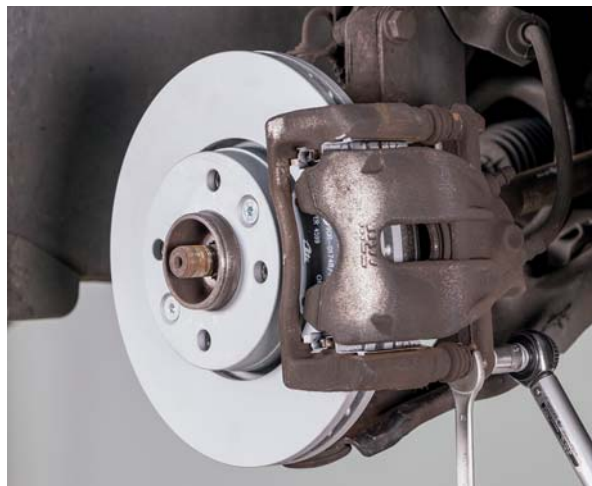

6.3 Generation 2

Preparatory work:

- Remove the wheel
- Loosen the brake caliper and hang it to one side in such a way that there is no tensile load on the brake hose
- Remove the brake pads if necessary
- Remove the brake carrier
- Remove the brake disc



- Remove the dust cap



- Unscrew the axle nut



- Pull the wheel bearing unit off the stub axle



- Pull the bearing inner ring off the stub axle



- Clean the stub axle and inspect for damage
- Attach the mounting tool



- Slide the wheel hub unit onto the stub axle as far as it will go
- Fit the wheel hub unit onto the stub axle using the special tool



- Remove the tool
- Tighten the new axle nut to the tightening torque specified by the vehicle manufacturer

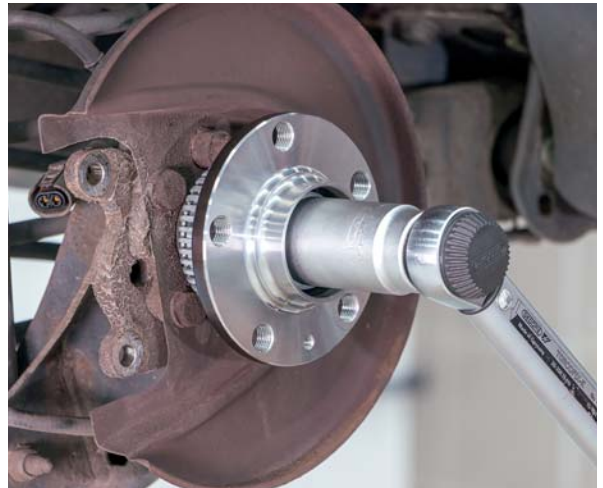

Final work:

- Attach the dust cap
- Install the brake disc, brake carrier, brake pads and brake caliper
- Mount the wheel



6.4 Generation 2D

Preparatory work:

- Loosen the axle nut/screw
- Remove the wheel
- Remove the axle nut/screw
- Loosen the brake caliper and hang it to one side in such a way that there is no tensile load on the brake hose
- Remove the brake disc
- Remove the wheel speed sensor
- Remove the driveshaft, or alternatively swivel it to the side if enough space is available



- Remove all the bolts/screws



- Remove the wheel bearing

Note:

If the wheel bearing unit cannot be easily removed from the steering knuckle, special pullers should be used for the dismantling operation.

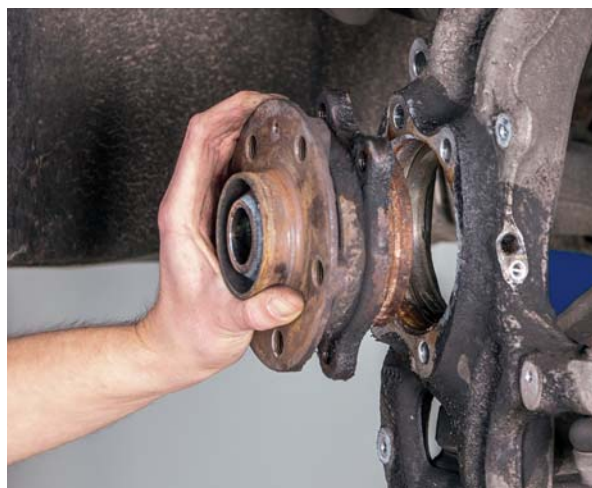

- Press out the wheel hub using a hydraulic press

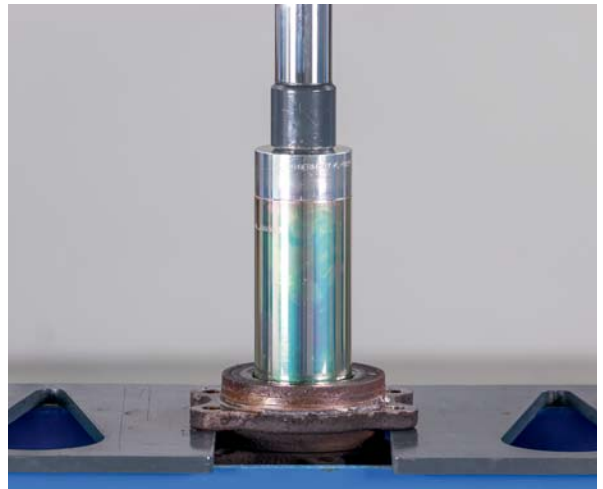

- Pull the bearing inner ring off the wheel hub
- Then clean and inspect the wheel hub



- Place the new wheel bearing on a flat surface with the polished flange side pointing downwards
- Press in the wheel hub
- Carefully place the wheel bearing unit on the wheel hub side



- Clean and inspect the wheel bearing seating



- Install the wheel bearing unit
- Tighten the bolts/screws to the tightening torque specified by the vehicle manufacturer



After the speed sensor, driveshaft and complete brake system have been reinstalled:

- tighten the axle bolt to the torque specified by the vehicle manufacturer

Important:

The wheels must not be subject to load while the central bolt is being tightened. The wheel bearing may otherwise suffer preliminary damage.



6.5 Generation 2.1 with snap ring

Preparatory work:

- Loosen the axle nut
- Remove the wheel
- Loosen the brake caliper and hang it to one side in such a way that there is no tensile load on the brake hose
- Remove the brake carrier
- Remove the brake disc
- Remove the driveshaft, or alternatively swivel it to the side if enough space is available
- Remove the speed sensor



- Attach the puller



- Remove the wheel bearing



- Inspect the bearing seat



- Clean the wheel bearing seat and the groove for the snap ring



- Carefully lay down the new wheel bearing on a workbench
- Slide both clamps together



- Tighten the bolts by hand in order to secure the clamps



Basics of mounting clamps:

The clamps ensure firstly that the wheel hub and the outer ring of the bearing are connected so that the forces are routed via the outer ring during the pressing-in process. They secondly ensure that the snap ring is held in position and engages in the groove at the end of the pressing-in process.

Note:

The wheel bearing must be pressed over the outer ring. The forces generated during the pressing-in process would otherwise be routed via the balls. This would result in the new wheel bearing suffering preliminary damage and failing prematurely.

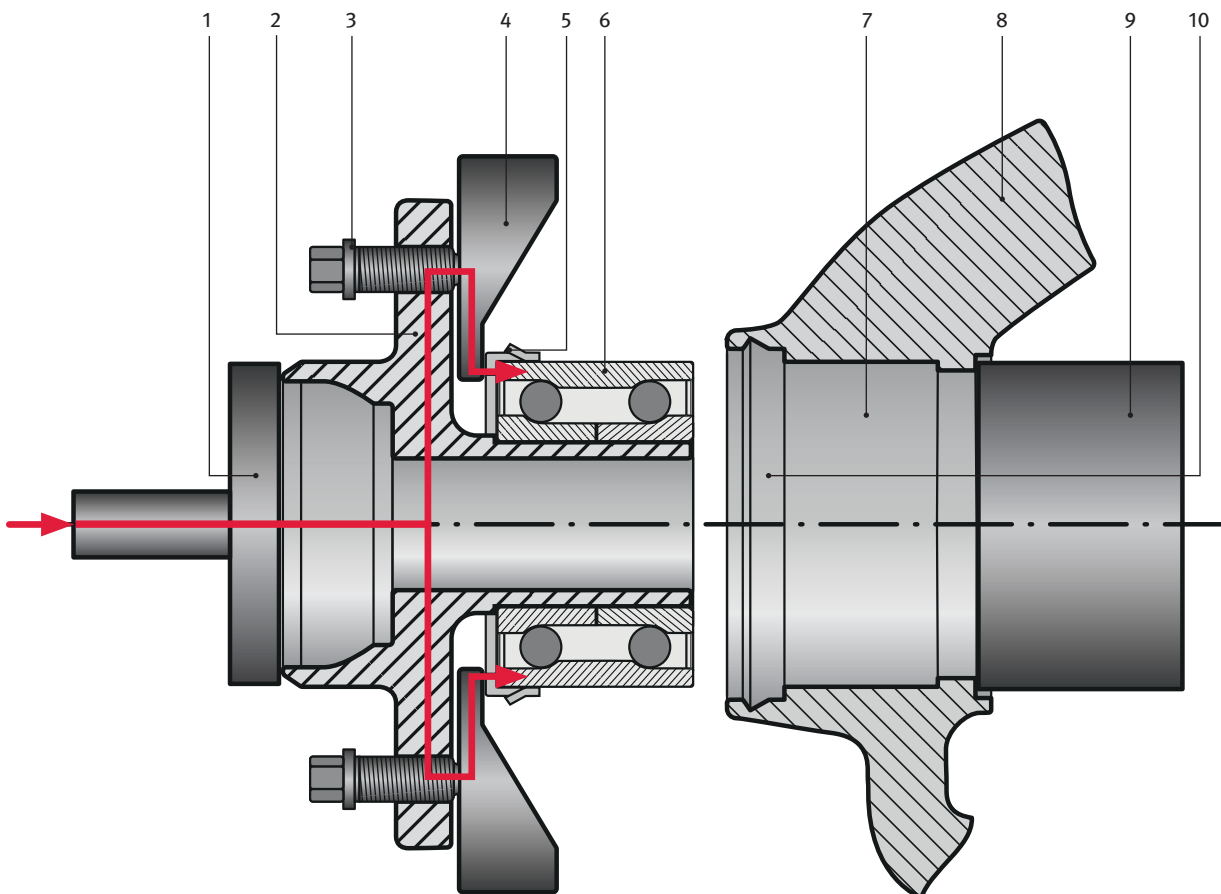
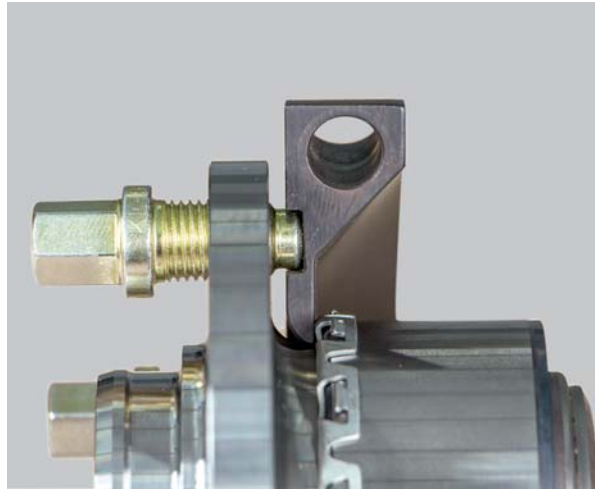

Path of forces during pressing-in process with mounted clamps

- | | |
|----------------|-------------------------|
| 1 Thrust piece | 6 Outer ring |
| 2 Wheel hub | 7 Bearing seating |
| 3 Bolt | 8 Steering knuckle |
| 4 Clamp | 9 Thrust piece |
| 5 Snap ring | 10 Groove for snap ring |

- Align the tool and wheel bearing for installation

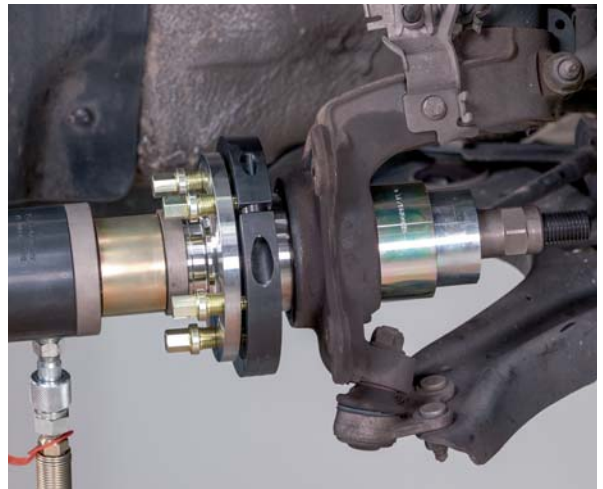

- Press in the wheel bearing until a clicking noise is heard from the snap ring



- Continue pressing until the pressure increases

Important:
This ensures that the snap ring is fully engaged in the groove.

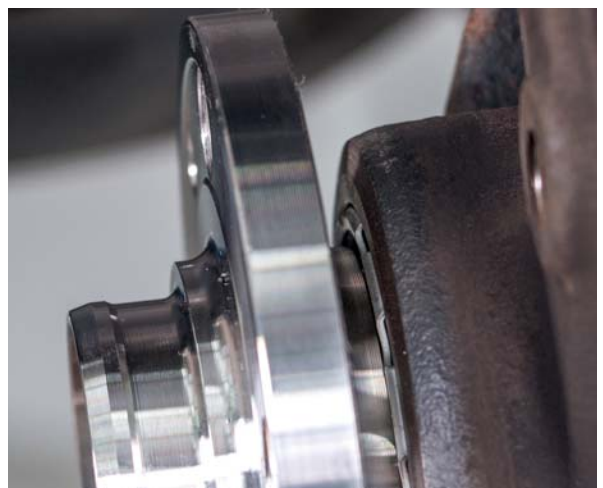

Final work:

- Install the wheel speed sensor
- Install the driveshaft
- Install the brake disc
- Install the brake carrier
- Install the brake caliper
- Tighten the axle nut to the tightening torque specified by the vehicle manufacturer
- Mount the wheel



6.6 Generation 3

Preparatory work:

- Loosen the axle nut/screw
- Remove the wheel
- Loosen the brake caliper and hang it to one side in such a way that there is no tensile load on the brake hose
- Remove the brake carrier and brake disc
- Remove the driveshaft, or alternatively swivel it to the side if enough space is available
- Remove the wheel speed sensor



- Unscrew the screws



- Take out the wheel bearing unit

Important:

If the wheel bearing unit cannot be easily removed from the steering knuckle, special pullers should be used for the dismantling operation.



- Clean and inspect the wheel bearing seating



- Insert the new wheel bearing unit



- Tighten the screws to the tightening torque specified by the vehicle manufacturer



After the speed sensor, the axle shaft and the brake caliper have been reinstalled:

- tighten the axle bolt to the torque specified by the manufacturer

Important:

The wheels must not touch the ground while the central bolt is being tightened. The wheel bearing may otherwise suffer preliminary damage.



7 Wheel bearing repair solution as a safety system

The FAG wheel bearing set is a professional repair solution with all the necessary accessories in OEM quality. Vehicle manufacturers stipulate that these accessories – for example mounting materials, protective caps, snap rings, or seals – must be replaced during the repair process.

The following illustrations show examples of some of the quality features of the bolts and nuts.

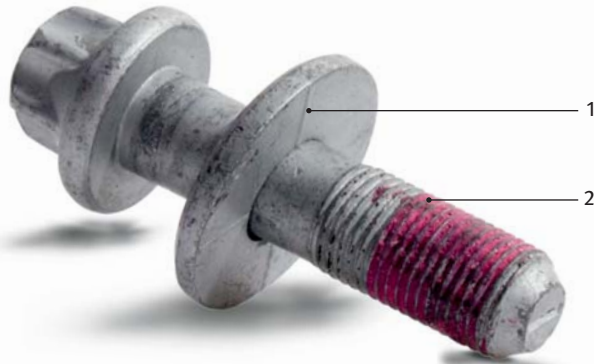

- 1 Trust washer with a knurled surface on the underside
- 2 Microencapsulated paint coating

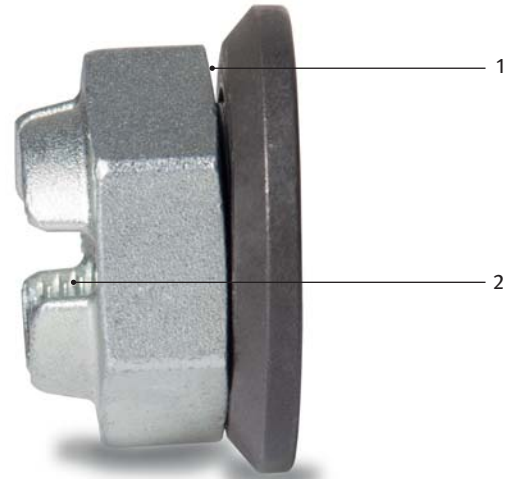

- 1 Secure mounting for thrust washer
- 2 Conically tapered thread



- 1 A multiple knurled surface on the underside of the screw head
- 2 Stretch bolt with a tapered shank



- 1 Elastically deformable nylon insert (white)
- 2 Warning message



- 1 Oval thread shape

Note:

Professional repair work compliant with the vehicle manufacturer's specifications can only be guaranteed by using the accessories included, such as expansion screws and self-locking nuts.

