

DIRECTIONAL BRAKE PADS



INTRODUCTION

One of the biggest challenges presented to brake pad manufacturers by vehicle manufacturers is to control and reduce brake noise.

To solve the problem, with some specific brake systems, there has been the development of the asymmetrical brake pad designs which introduce the brake pad to the disc at an angle. In doing so, the potential for vibration and noise is significantly reduced.

Jurid deploys two methods to achieve the angle of introduction. One is the use of a chamfer on the friction surface and the second is a cut-out of the noise reduction shim on the backing plate. Both are easy for the technician to see and understand that the pads need to be positioned in a specific way.

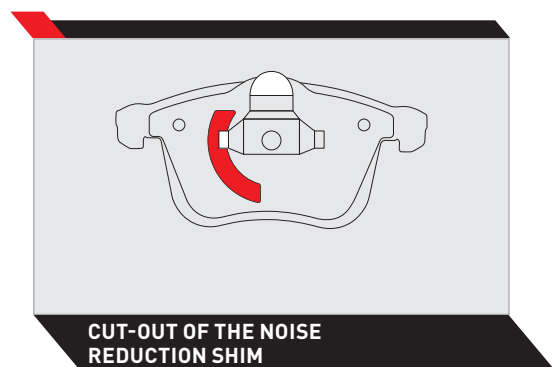
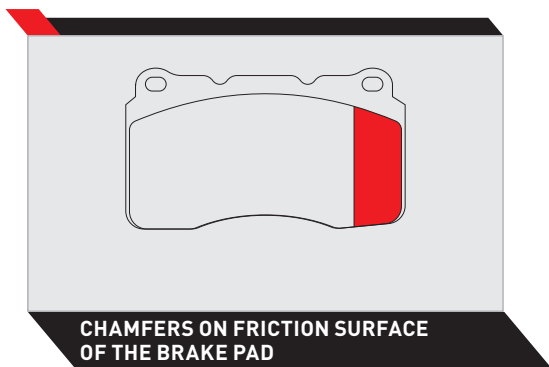

FITTING DIRECTIONAL BRAKE PADS

Many directional pads have an arrow on the back plate to indicate the rotational direction of the brake disc. When fitting these brake pads, make sure the arrow

points in the same direction as the wheels turn during forward driving.

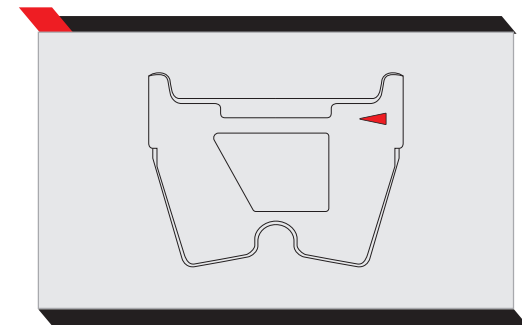
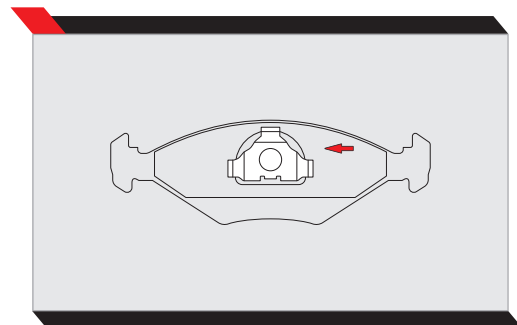

DIRECTIONAL BRAKE PADS



Some directional pads do not use an arrow but instead include a letter. The letter indicates to which side of the vehicle the brake pad should be fitted.

When the letter R is used, the brake pad should be fitted to the right-hand side of the vehicle. When an L is used, fit it to the left-hand side.

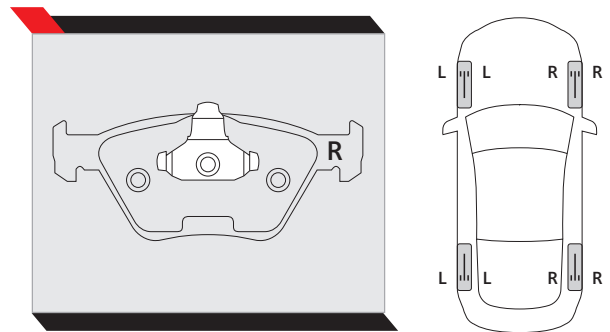

▼ FITTING BRAKE PADS WITH A CHAMFER ON THE FRICTION SURFACE

If no arrow or letter is used but the Jurid pads are equipped with a chamfer, the chamfer needs to be presented at the leading edge where the pad first contacts the brake disc when fitting the brake pads.

Where the pads are equipped with a chamfer on both edges, the edge with the bigger chamfer area should be presented to the leading edge where the pad first contacts the brake disc.

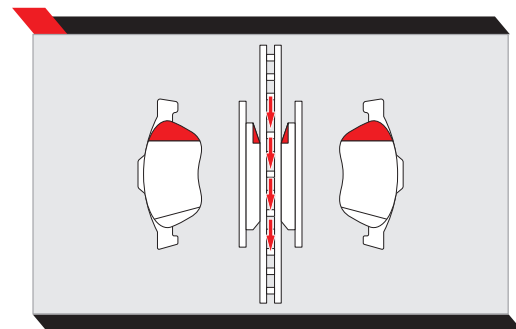

▼ FITTING BRAKE PADS WITH A CRESCENT CUT-OUT TO THE NOISE REDUCTION SHIM

If no arrow or letter is used but the Jurid pads are equipped with a crescent or half-moon cut-out from the noise reduction shim, the crescent or half-moon needs to be presented at the leading edge where the pad first contacts the brake disc.

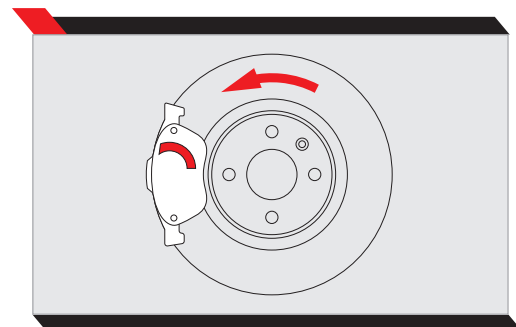

DIRECTIONAL BRAKE PADS



DISCOVER OUR DETAILED INSTALLATION VIDEOS ON  **YouTube**

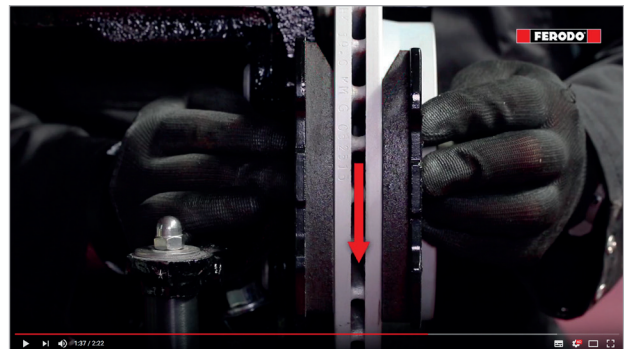
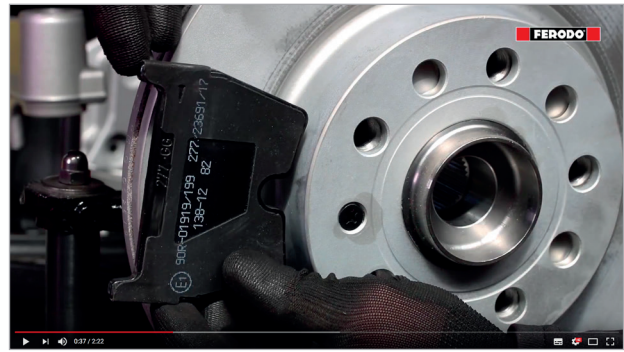

For informational purposes only. We are not liable for any damages resulting from your reliance on this content.